

1ST PRINTING NOV 01



ADDENDUM to the OWNER'S MANUAL

CARD READER REPLACEMENT INSTALLATION INSTRUCTIONS

STANDARD & DELUXE VERSION



SEGA ENTERPRISES, INC. USA

PART NO. 999-1367

VISIT OUR WEBSITE!

SegaService.com

Back Forward Refresh Stop Home Sherlock Preferences Larger Smaller Stop

Address: <http://www.seuservice.com/> go

Apple Central.Sega.com Sega.com SegaService.com Yahoo! Yahoo! Maps and Driving Directions

SEGA SERVICE

Ask Dave!

- what's new
- manuals
- bulletins
- assemblies
- Search

bulletin Sign-up
register name

staff
Darl's Office
tech. service
warranty policy

corporate info
home page
future technologies
plugins
non-framed page

Sega Enterprises Inc.,
USA
Service Department
phone 415.701.6580
fax 415.701.6594

SEGA SERVICE

- Bulletins
- Darl's Office
- Game Manuals
- Search
- What's New

5564 people have visited this page since 3/16/01

If you have any questions or comments
about this site please E-Mail to Darl.Davidson@seu.sega.com

THIS WEB SITE POWERED BY
WebSTAR 4.3 Mac OS

[\[what's new\]](#)[\[manuals\]](#)[\[bulletins\]](#)[\[assemblies\]](#)[\[Search\]](#)[\[staff\]](#)[\[Darl's office\]](#)
[\[technical service\]](#)[\[customer service\]](#)[\[corporate info\]](#)[\[plugins\]](#)[\[Non-framed page\]](#)

You will need the following items to view this page in its entirety.

Get Acrobat Reader **GET Microsoft Internet Explorer** **GET Microsoft Internet Explorer**

All Platforms Windows Macintosh

Internet Zone

Warranty

Your new Sega Product is covered for a period of 90 days from the date of shipment. This certifies that the Printed Circuit Boards, Power Supplies and Monitor are to be free of defects in workmanship or materials under normal operating conditions. This also certifies that all Interactive Control Assemblies are to be free from defects in workmanship and materials under normal operating conditions. No other product in this machine is hereby covered.

Sellers sole liability in the event a warranted part described above fails shall be, at its option, to replace or repair the defective part during the warranty period. For Warranty claims, contact your Sega Distributor.

Should the Seller determine, by inspection that the product was caused by Accident, Misuse, Neglect, Alteration, Improper Repair, Installation or Testing, the warranty offered will be null and void.

Under no circumstances is the Seller responsible for any loss of profits, loss of use, or other damages.

This shall be the exclusive written Warranty of the original purchaser expressed in lieu of all other warranties expressed or implied. Under no circumstance shall it extend beyond the period of time listed above.

TABLE OF CONTENTS

BEFORE USING THE PRODUCT, BE SURE TO READ THE FOLLOWING:
TABLE OF CONTENTS

CLUB KART STANDARD

1. CARD READER REPLACEMENT INSTALLATION	
INSTRUCTION FOR STANDARD GAME ONLY	5
2. DESIGNED RELATED PARTS	10
3. PLACEMENT OF DECALS	11
4. PARTS LIST	12

CLUB KART DELUXE

1. CARD READER REPLACEMENT INSTALLATION	
INSTRUCTION FOR STANDARD GAME ONLY	17
2. DESIGNED RELATED PARTS	20
3. PLACEMENT OF DECALS	21
4. PARTS LIST	22
3. WIRING DIAGRAM	25

HOW TO USE THIS ADDENDUM BOOKLET



IMPORTANT!

Please read and understand instructions completely before attempting this procedure.



IMPORTANT!

This booklet is designed to be used with the original service manual issued with this game. It contains modifications to both the wiring diagrams and parts assemblies detailed within the Parts Lists section of your service manual.

Card Reader Replacement Installation Instructions for STANDARD Game Only

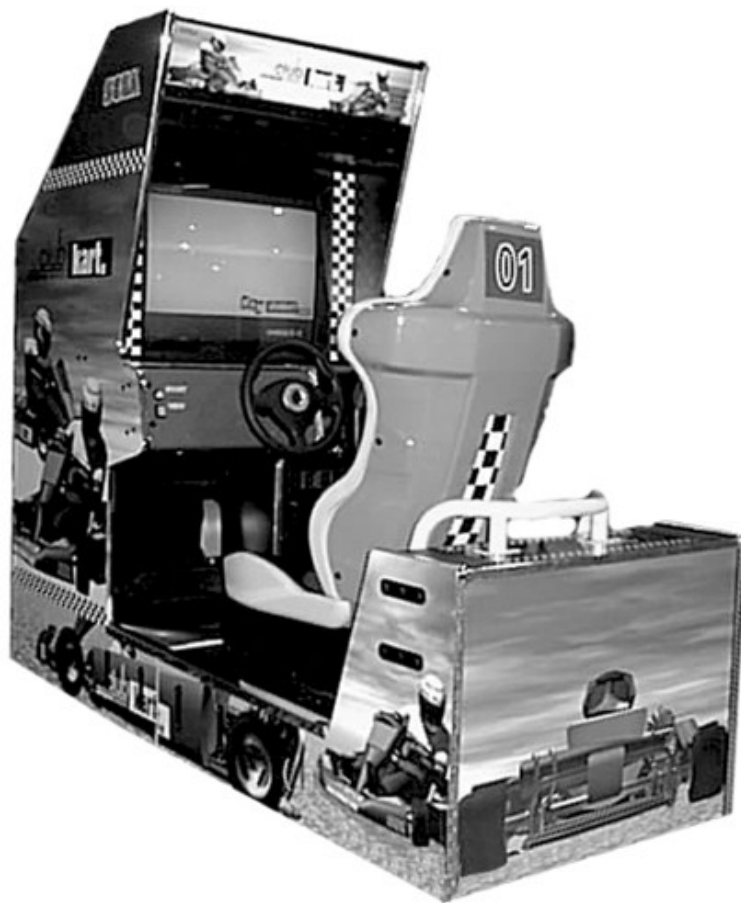

club kart standard

Card Reader Replacement Installation Instruction for Standard Game Only

STEP 1

1. Turn OFF power to the Club Kart game and unplug AC from the Power Outlet.
2. Using the Key, open the Card Reader Compartment.
3. Carefully remove both VHR 6P Connectors and JST 5P Connectors at the Card Reader Filter BD (The Filter BD, Sega P/N 837-13844 is located on the right of the Card Reader).
4. Remove the Earth Ground Wire (Green Wire), and unplug the Power Supply Harness going to the Opto Coupler.

INSIDE CARD READER BOX

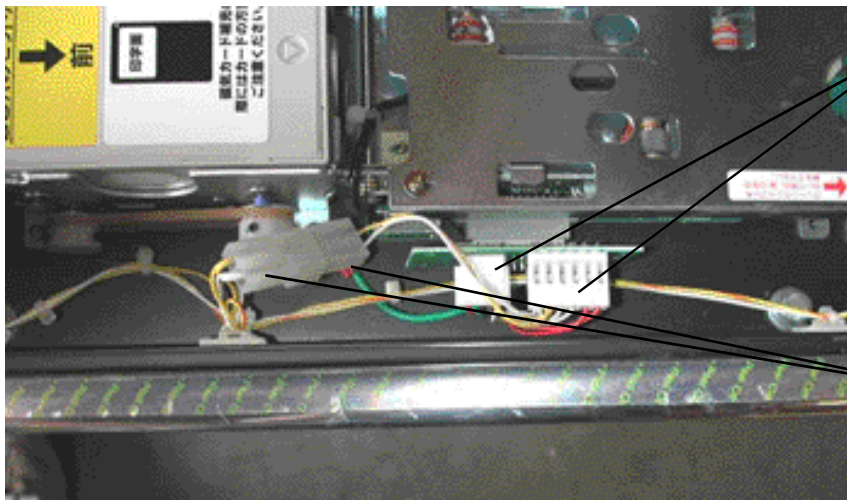

REMOVE THESE
CONNECTORS FROM
FILTER BD

DISCONNECT THESE

PHOTO 5

club kart standard

STEP 2

1. Using a T27 Tamper Proof Wrench (Provided with your game at time of shipment), unscrew the 4 Tamper Proof Bolts that secure the Card Reader Box to the Game.
(Save these bolts for use later!!)
2. Carefully remove the Card Reader Harness from the metal compartment.

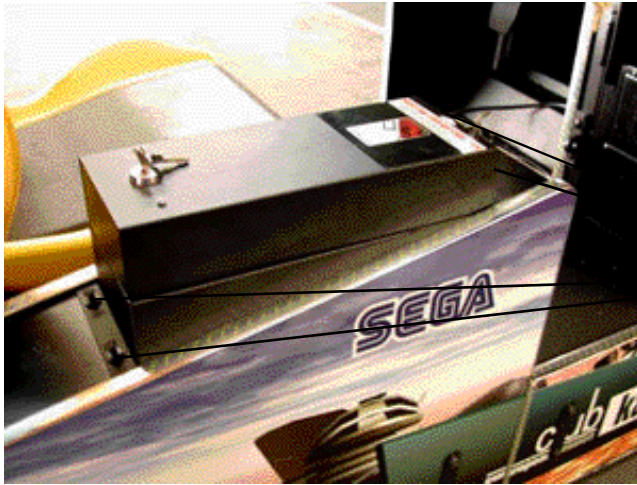

REMOVE THESE 4 BOLTS
(T27 TAMPER PROOF) SAVE
FOR USE LATER!!

PHOTO 6 a

STEP 3

1. At the Cabinet Card Reader opening, carefully pull the Green Ground Wire until the White Connector is exposed.

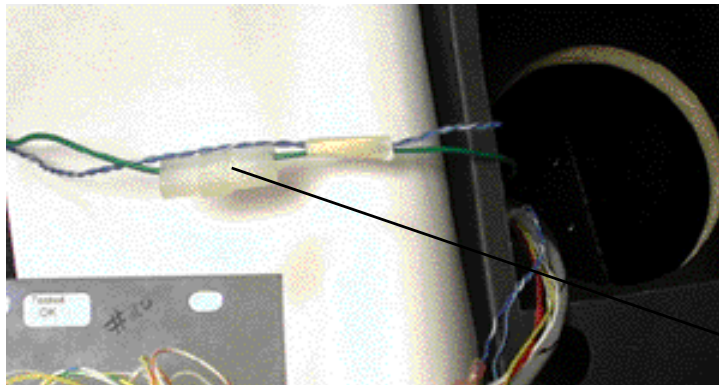

PULL UNTIL THIS CONNECTOR
APPEARS. (NOTE: BLUE WIRE TO
BE ATTACHED IN STEP 4)

PHOTO 6 b

club kart standard

STEP 4

1. Remove the Card Reader Replacement Unit from its shipping carton.
2. Unwind the Blue Wires (Twisted Approximately 86" long). Attach the end of the Blue Wires with tape to the Green Ground Wire exposed in Step 3 (Near White Connectors. This leaves enough length in the Green Wire to pull it back into place after it is used to guide the Blue Wires into place).

Note: The Earth Ground Wire is only being used as a convenient means to guide the new Blue Wires into place. Care must be taken not to damage the wire, or separate the connector. It will need to be used as a ground for the Button Panel to ground it.

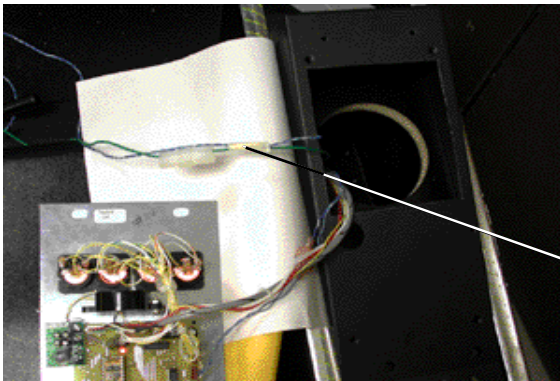

TAPE BLUE WIRES HERE

PHOTO 7 a

3. From the back of the game, just below the NAOMI 2 Game BD, there is a 4" circular opening for the game harnesses. At this opening, very carefully pull the Green Ground Wire until the Blue Wires you taped become exposed.
4. Remove the tape to separate both Blue Wire from the Green Ground Wire. Gently pull on the Blue Wires to expose enough wire to go to the I/O BD (The I/O BD is located at the upper left of the electronics area of the back of the game).
5. Pull the Green Wire carefully back into position for attachment to the Button Plate.

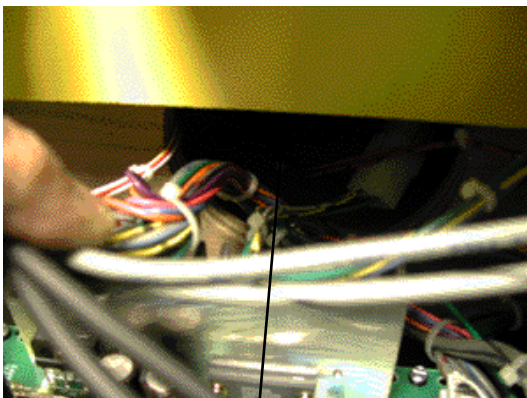

PHOTO 7 b

CIRCULAR OPENING

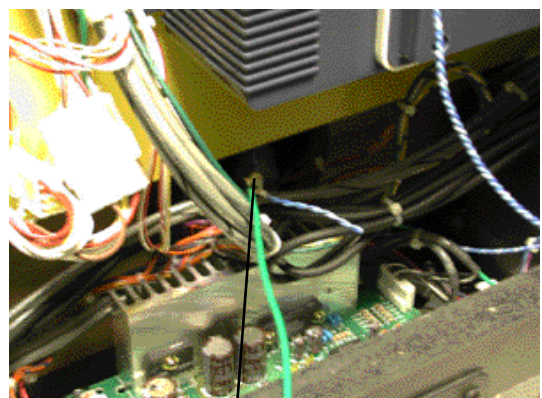

PHOTO 7 c

WIRES PULLED
THROUGH OPENING

club kart standard

STEP 5

1. On the I/O BD, locate CN7 Pin 9 (Blue Wire).
2. Using a pair of Wire Cutters, cut the Blue Wire from CN7 approximately 3" from the Connector. Strip off approximately 1/8" of the insulation off.
3. Using a Bell Connector (provided) connect the **Blue/White wire to the end of the Blue Wire that comes from the Wiper of the Accelerator Potentiometer.**
4. Connect the **Blue Wire from the Twisted wires to the Blue Wire that goes to CN7 Pin 9.**

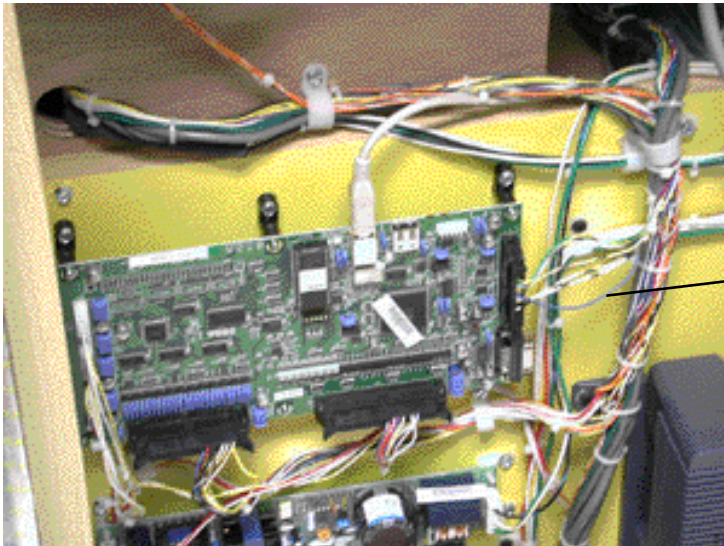

WIRE TO BE CUT

PHOTO 8 a

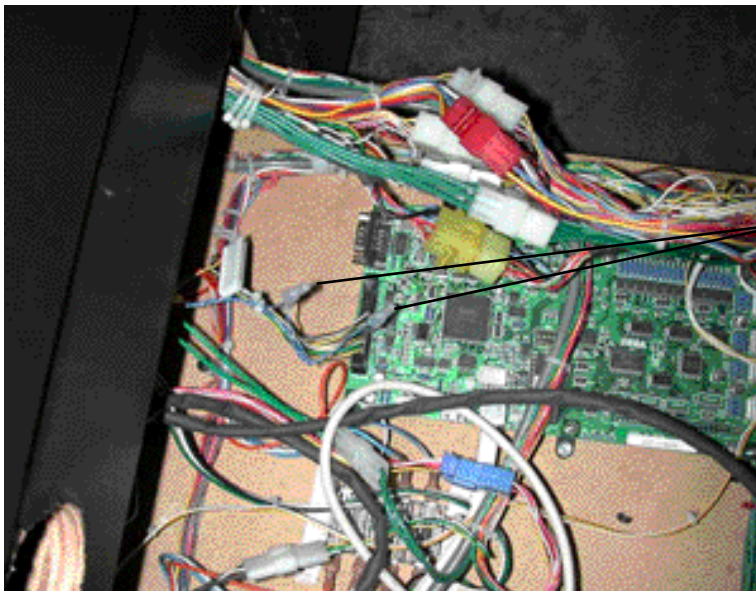

WIRES CONNECTED WITH CRIMPS

PHOTO 8 b

club kart standard

STEP 6

1. Plug JSPT P5 and J2 Connectors from the existing Card Reader Harness into the Card Reader Replacement Board. Attach the Earth Ground (Green Wire) to the Male Pem screw on the Button Panel. Secure with Screw. Be careful to ground yourself while handling this board.

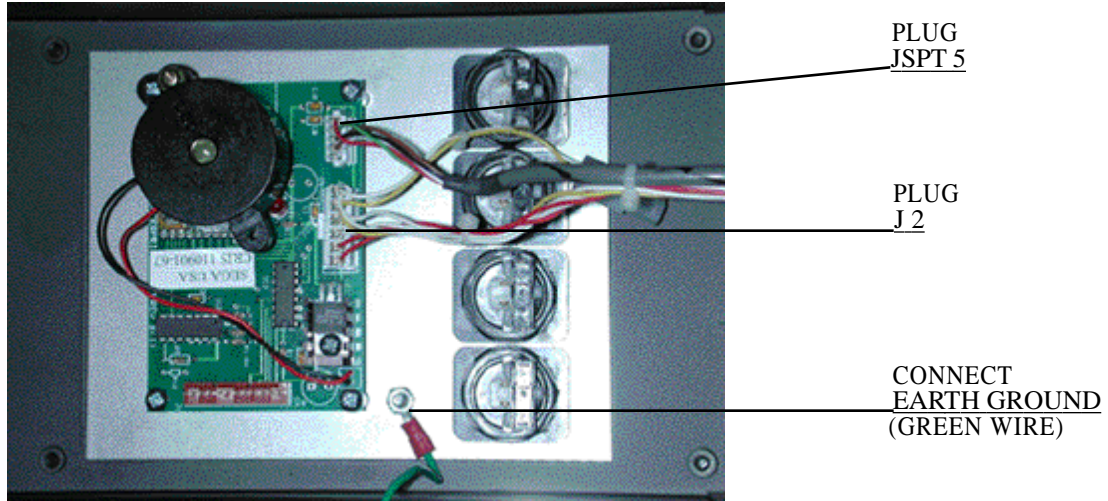

PHOTO 9 a

2. Secure the Button Panel to the Game Cabinet using the 4 Tamper Proof Bolts removed in Step 2.



PHOTO 9 b

PANEL INSTALLED ON THE GAME

If you require further assistance, contact your authorized **SEGA DISTRIBUTOR**, or **SEGA TECHNICAL** Services at (415) 701-6580
Mondays - Fridays 7:30am to 4:00pm(Pacific Standard Time)

DESIGNED RELATED PARTS

BUTTON PLATE DECAL
999-1354

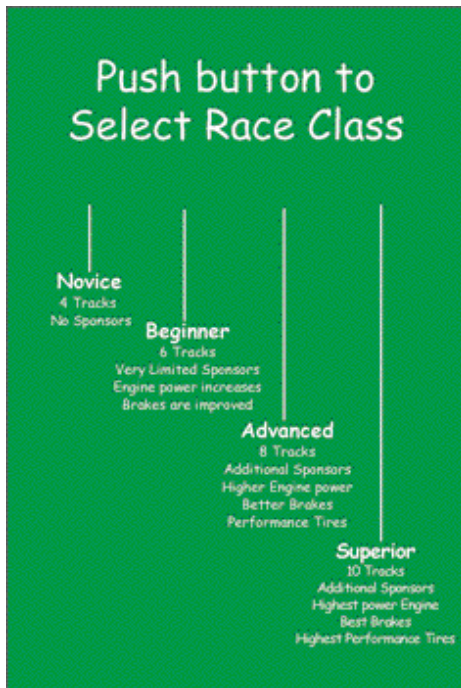

NO CARD DECAL 999-1358

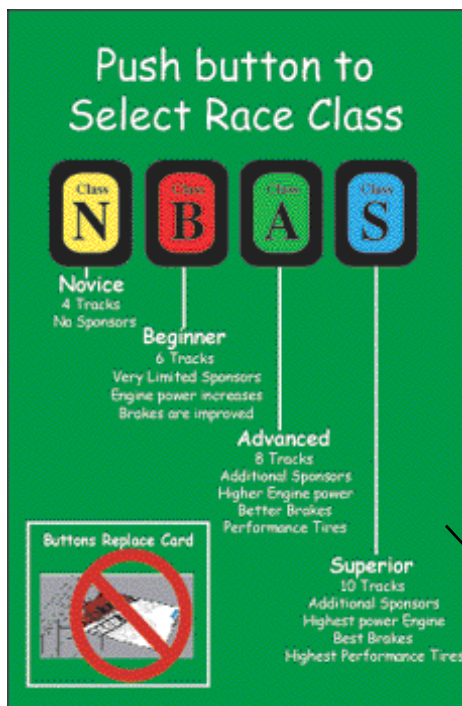
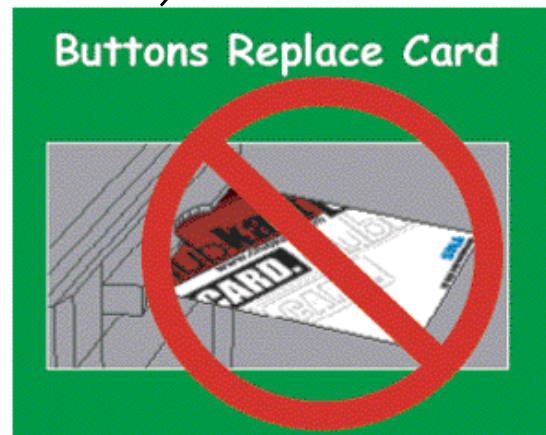

MONITOR DECAL - STD 999-1357

PLACEMENT OF DECALS

MONITOR DECAL - STD 999-1357

NO CARD DECAL
999-1358

BUTTON PLATE DECAL
999-1354



club kart Standard

CARD READER REPLACEMENT INSTALLATION KIT CONTAIN LIST

Part #	Description	Locatrion	Qty
998-0150	Printed Circuit Board Assy	Mounted to Button Plate	1
Local Purchase	1.0k OHM 1/8W 5% Carbon Film Resistor	R1-R5, R10, R11, R13	7
Local Purchase	Mzxim RS232A Line Driver	IC4	1
Local Purchase	T-1 Difused Red (LED)	LED 1	1
Local Purchase	Cap 1000UF 25V Elect FC Radial	C4, C5	2
Local Purchase	Cap 50V .1uf Axial Ceramic Z5U	C1, C2, C3, C6, C7, C8, C9, C10	8
Local Purchase	IC Quad Bilateral Switch (DIP) MC14066	IC2	1
Local Purchase	ULN2003AN	IC3	1
Local Purchase	12 Pin In-Line Connector	J1	1
Local Purchase	Heat Sink	VR1	1
Local Purchase	5 Position Header (B5P-SHF-1AA)	J3	1
Local Purchase	6 Position Header (B6P-VH)	J2	1
998-0151	BS2p Stamp	IC1	1
Local Purchase	Voltage +5 Volt Regulator	VR1	1
999-1370	HARNESS (Grand Products)	Main Harness connected to Button Plate	1
Local Purchase	L-Bracket Small for Beeper (PCB Standoff)	Holder for Beeper	1
999-1353	Button Plate Blank		1
Local Purchase	#6/32 X 3/8" Screw	Used to Assmbl PCB Button Plate	6
Local Purchase	#6/32 Nut	Used to Assmbl PCB Button Plate	3
Happ Ctrls	VLT PB MED REC Red, Red Cap 12V Lamp, DA3 MS	Button Plate	1
Happ Ctrls	VLT PB MED REC Blue, Blue Cap 12V Lamp, DA3 MS	Button Plate	1
Happ Ctrls	VLT PB MED REC Green, Green Cap 12V Lamp, DA3 MS	Button Plate	1
Happ Ctrls	VLT PB MED REC Yellow, Yellow Cap 12V Lamp, DA3 MS	Button Plate	1
Local Purchase	Piezoelectric Ceramic Buzzer Unit	B1	1
999-1371	Button Inserts N, B, A, S	Insert into Happ Buttons	1
999-1354	Button Plate Decal	Placed on Metal Plate	1
999-1352	Angle Box STD Only	Under button Plate STd	1
Local Purchase	1/2" X 8/32" Security Torx Screw (Black)	Used to Mount the Button Plate to the Angle Box	4
999-1357	Monitor Bezel Decal - STD	Inside Monitor on Right Side	1
999-1358	Button Replace Card Decal - STD	Above the Coin Door	1
999-1367	CRIS Kit Installation/Owner's Manual		1

BUTTON PLATE - 999-1353

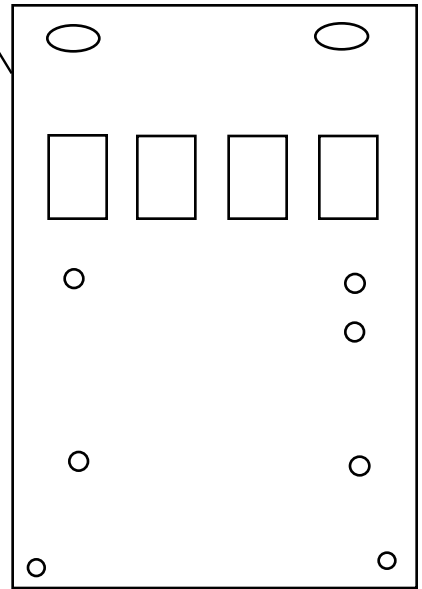

ANGLE BOX 999-1352



PRINTED CIRCUIT BOARD - 998-0150

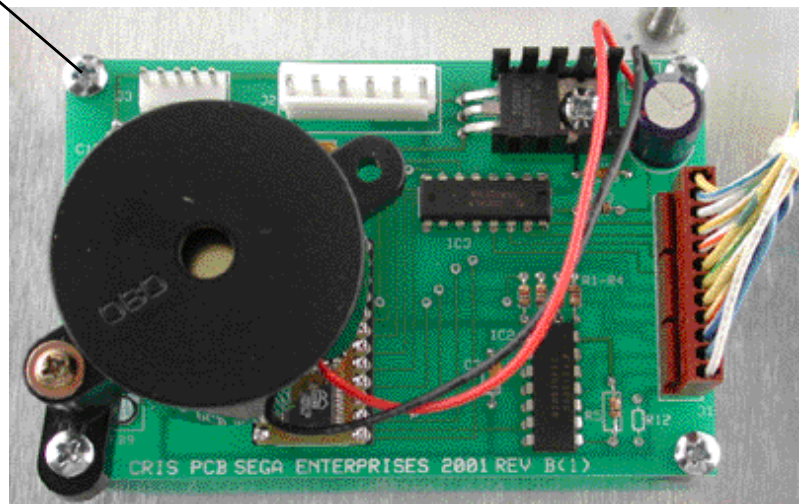

Card Reader Replacement Installation Instructions for DELUXE Game Only



club kart deluxe

Card Reader Replacement Installation Instruction for Deluxe Game Only

STEP 1

1. Turn OFF power to the Club Kart Game and unplug AC from the Power Outlet.
2. Using the Key, open the Card Reader Compartment.
3. Carefully remove both VHR 6P Connectors and JST 5P Connectors at the Card Reader Filter BD (The Filter BD, Sega P/N 837-13844 is located on the right of the Card Reader).
4. Remove the Earth Ground Wire (Green Wire), and unplug the Power Supply Harness going to the Opto Coupler.

INSIDE CARD READER BOX

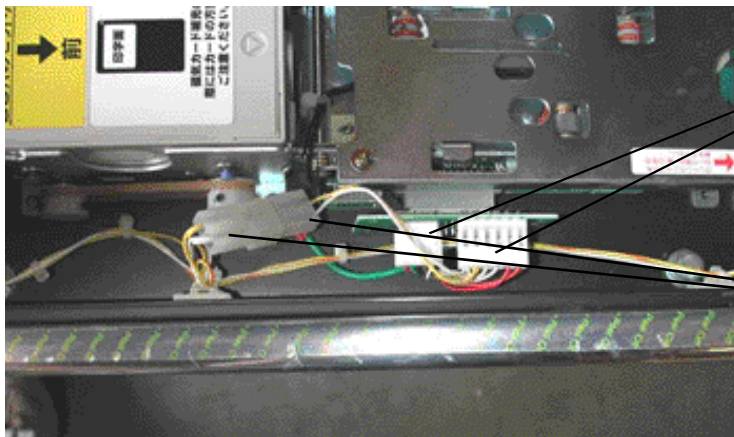

REMOVE THESE
CONNECTORS FROM
FILTER BD

DISCONNECT THESE

PHOTO 17

STEP 2

1. Remove Card Reader Replacement Unit from its Shipping Carton.
2. Unwind the Blue Wires (Twisted approximately 86" long).
3. Carefully feed the ends of the Twisted Blue Wires through the opening of the Card Reader Compartment and through opening in floor of the Sub Cabinet.
4. Remove Front Lid from Sub Cabinet and pull the Blue Wires through until the end of the wires are able to reach the Naomi I/O BD (The I/O BD is mounted in the Front of the machine near the Servo Diver Bd.). note: USB Cable Connection to I/O Bd.

club kart deluxe

STEP 3

1. On the I/O BD, locate the CN7 Pin 9 (Blue Wire).
2. Using a pair of wire cutters, cut the Blue Wire from CN7 approximately 3" from the Connector. Strip off approximately 1/8" of the insulation off.
3. Using a Bell Connector (provided) connect the **Blue/White Wire** to the end of the **Blue Wire that comes from the Wiper of the Accelerator Potentiometer.**
4. Connect the **Blue Wire from the Twisted Wires** to the **Blue Wire** that goes to **CN7 Pin 9**

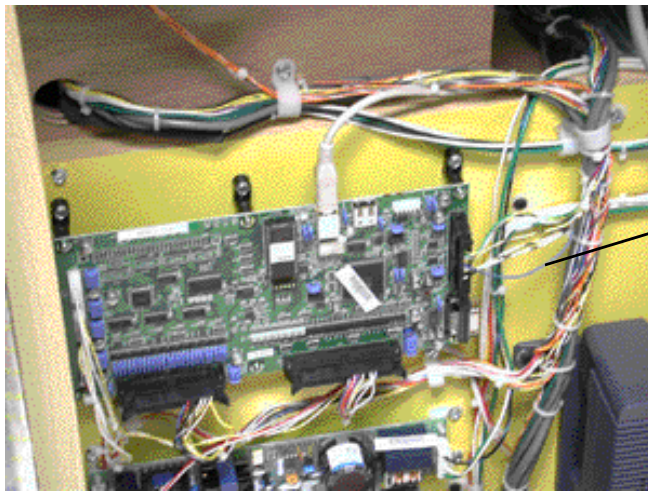

WIRE TO BE CUT

PHOTO 18 a

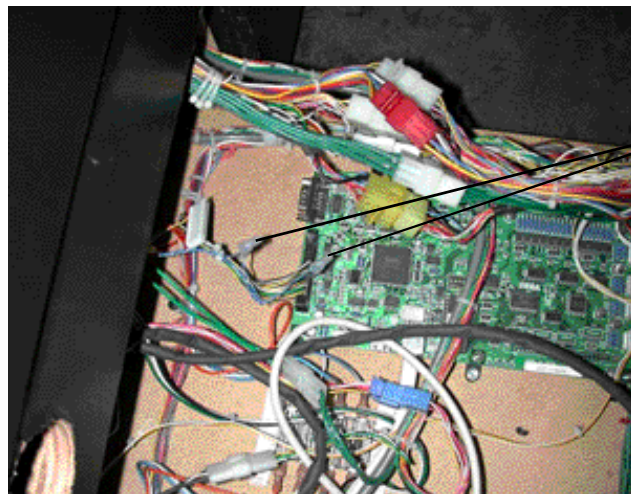

WIRES CONNECTED WITH CRIMPS

PHOTO 18 b

club kart deluxe

STEP 4

1. Plug JSPT P5 and J2 Connectors from the existing Card Reader Harness into the Card Reader Replacement Board. Attach the Earth Ground (Green Wire) to the Male Pem screw on the Button Panel. Secure with screw. Be careful to ground yourself while handling this board.

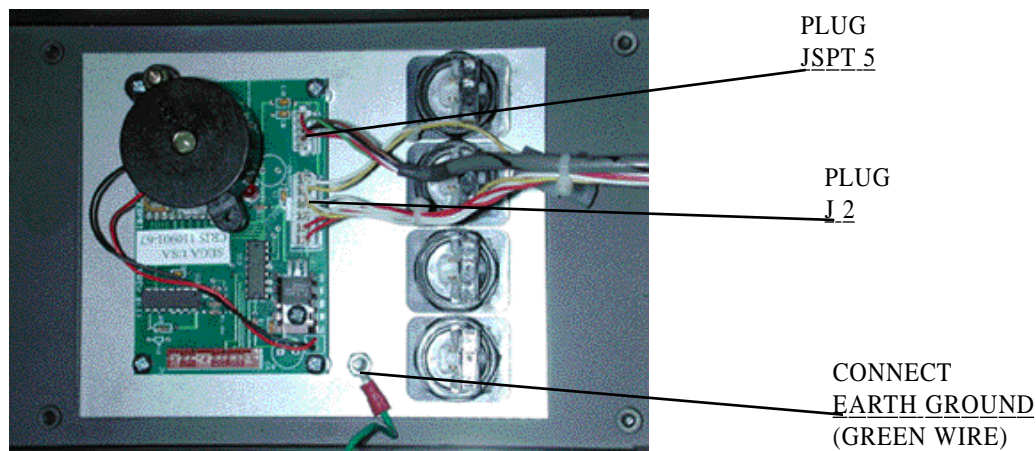

PHOTO 19 a

2. Secure the Button Panel to the Game Cabinet using the 4 wood screws (provided).

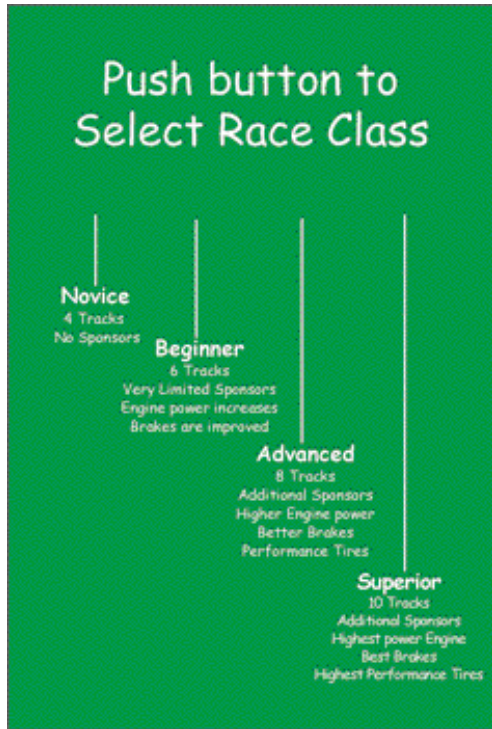

PHOTO 19 b

PANEL INSTALLED ON THE GAME

If you require further assistance, contact your authorized **SEGA DISTRIBUTOR**, or **SEGA TECHNICAL** Services at (415) 701-6580 Mondays - Fridays 7:30am to 4:00pm(Pacific Standard Time)

DESIGNED RELATED PARTS



BUTTON PLATE DECAL 999-1354

LARGE NO CARD DECAL 999-1356

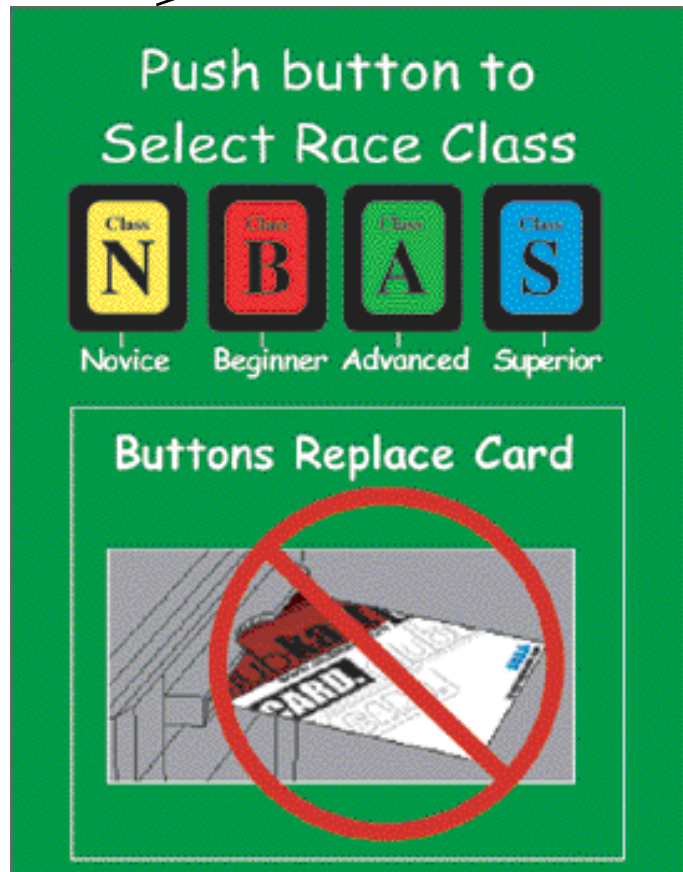

COIN TOWER POP PANEL 999-1355

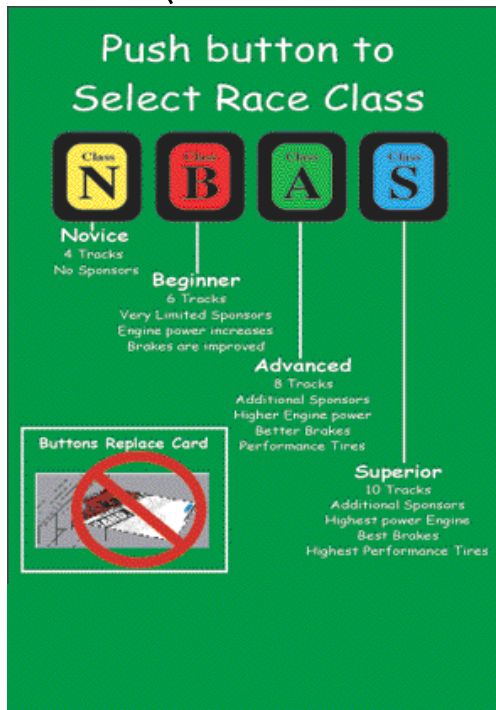

PLACEMENT OF DECALS

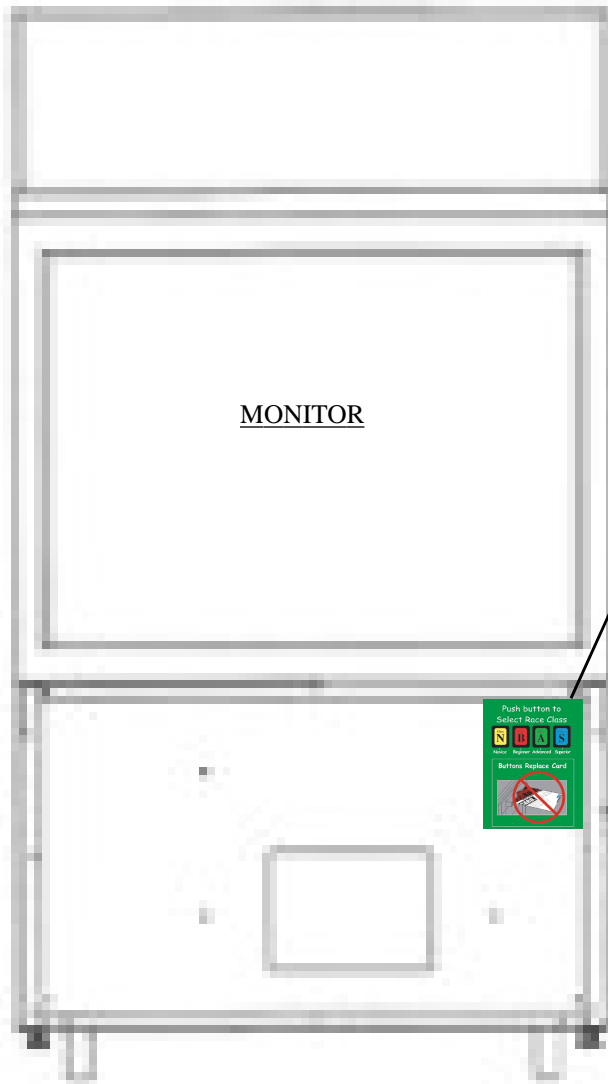

LARGE NO CARD DECAL
999-1356



COIN TOWER POP PANEL
999-1355

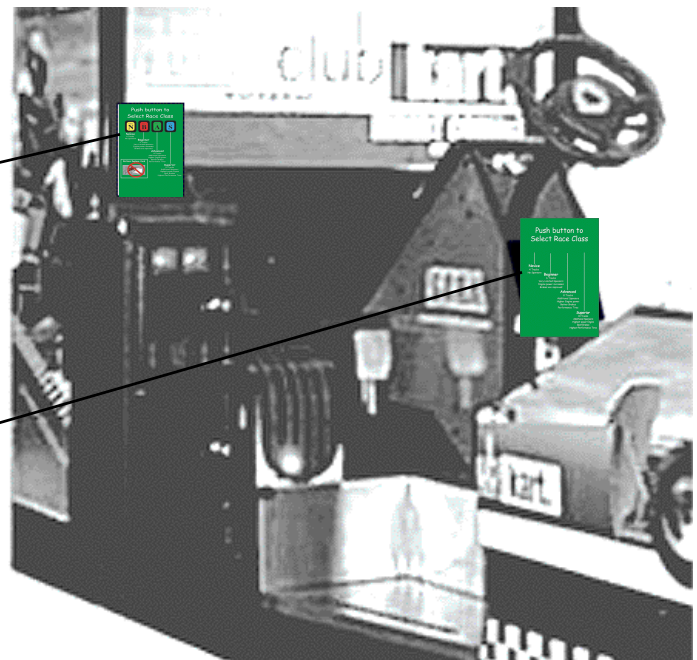

BUTTON PLATE DECAL 999-1354



club kart Deluxe

CARD READER REPLACEMENT INSTALLATION KIT CONTAIN LIST

Part #	Description	Locatrion	Qty
998-0150	Printed Circuit Board Assy	Mounted to Button Plate	1
Local Purchase	1.0k OHM 1/8W 5% Carbon Film Resistor	R1-R5, R10, R11, R13	7
Local Purchase	Mzxim RS232A Line Driver	IC4	1
Local Purchase	T-1 Difused Red (LED)	LED 1	1
Local Purchase	Cap 1000UF 25V Elect FC Radial	C4, C5	2
Local Purchase	Cap 50V .1uf Axial Ceramic Z5U	C1, C2, C3, C6, C7, C8, C9, C10	8
Local Purchase	IC Quad Bilateral Switch (DIP) MC14066	IC2	1
Local Purchase	ULN2003AN	IC3	1
Local Purchase	12 Pin In-Line Connector	J1	1
Local Purchase	Heat Sink	VR1	1
Local Purchase	5 Position Header (B5P-SHF-1AA)	J3	1
Local Purchase	6 Position Header (B6P-VH)	J2	1
998-0151	BS2p Stamp	IC1	1
Local Purchase	Voltage +5 Volt Regulator	VR1	1
999-1370	HARNESS (Grand Products)	Main Harness connected to Button Plate	1
Local Purchase	L-Bracket Small for Beeper (PCB Standoff)	Holder for Beeper	1
999-1353	Button Plate Blank		1
Local Purchase	#6/32 X 3/8" Screw	Used to Assmbl PCB Button Plate	6
Local Purchase	#6/32 Nut	Used to Assmbl PCB Button Plate	3
Happ Ctrls	VLT PB MED REC Red, Red Cap 12V Lamp, DA3 MS	Button Plate	1
Happ Ctrls	VLT PB MED REC Blue, Blue Cap 12V Lamp, DA3 MS	Button Plate	1
Happ Ctrls	VLT PB MED REC Green, Green Cap 12V Lamp, DA3 MS	Button Plate	1
Happ Ctrls	VLT PB MED REC Yellow, Yellow Cap 12V Lamp, DA3 MS	Button Plate	1
Local Purchase	Piezoelectric Ceramic Buzzer Unit	B1	1
999-1371	Button Inserts N, B, A, S	Insert into Happ Buttons	1
999-1354	Button Plate Decal	Placed on Metal Plate	1
999-1360	Black Filler Plate DLX Only	Behind Button Plate on DLX	1
Local Purchase	3/4" Phillips Button Head Black Wood Screw (DLX Mounting Only)		4
999-1356	Large NO CARD Decal	Placed at Lower Right of Monitor	1
999-1355	Coin Tower POP Panel	Placed above the Coin Tower	1
999-1367	CRIS Kit Installation/Owner's Manual		1

BUTTON PLATE - 999-1353

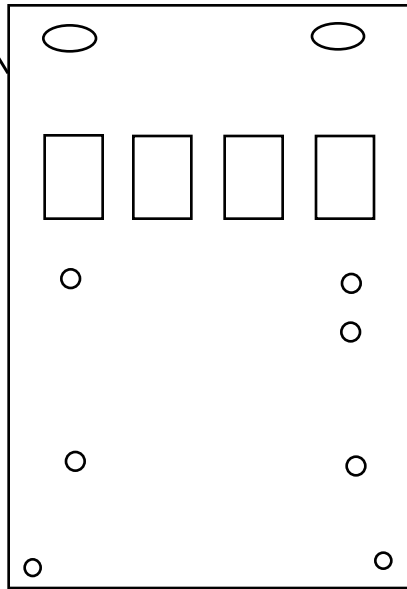

BLACK FILLER PLATE - 999-1360



PRINTED CIRCUIT BOARD - 998-0150

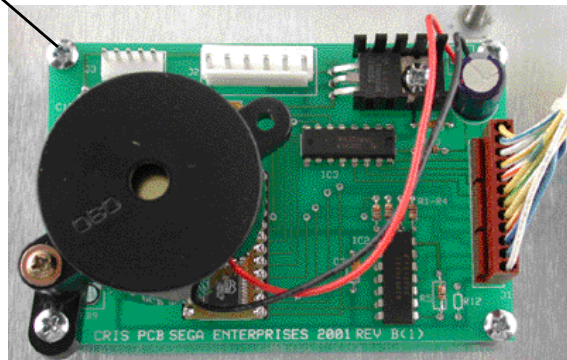

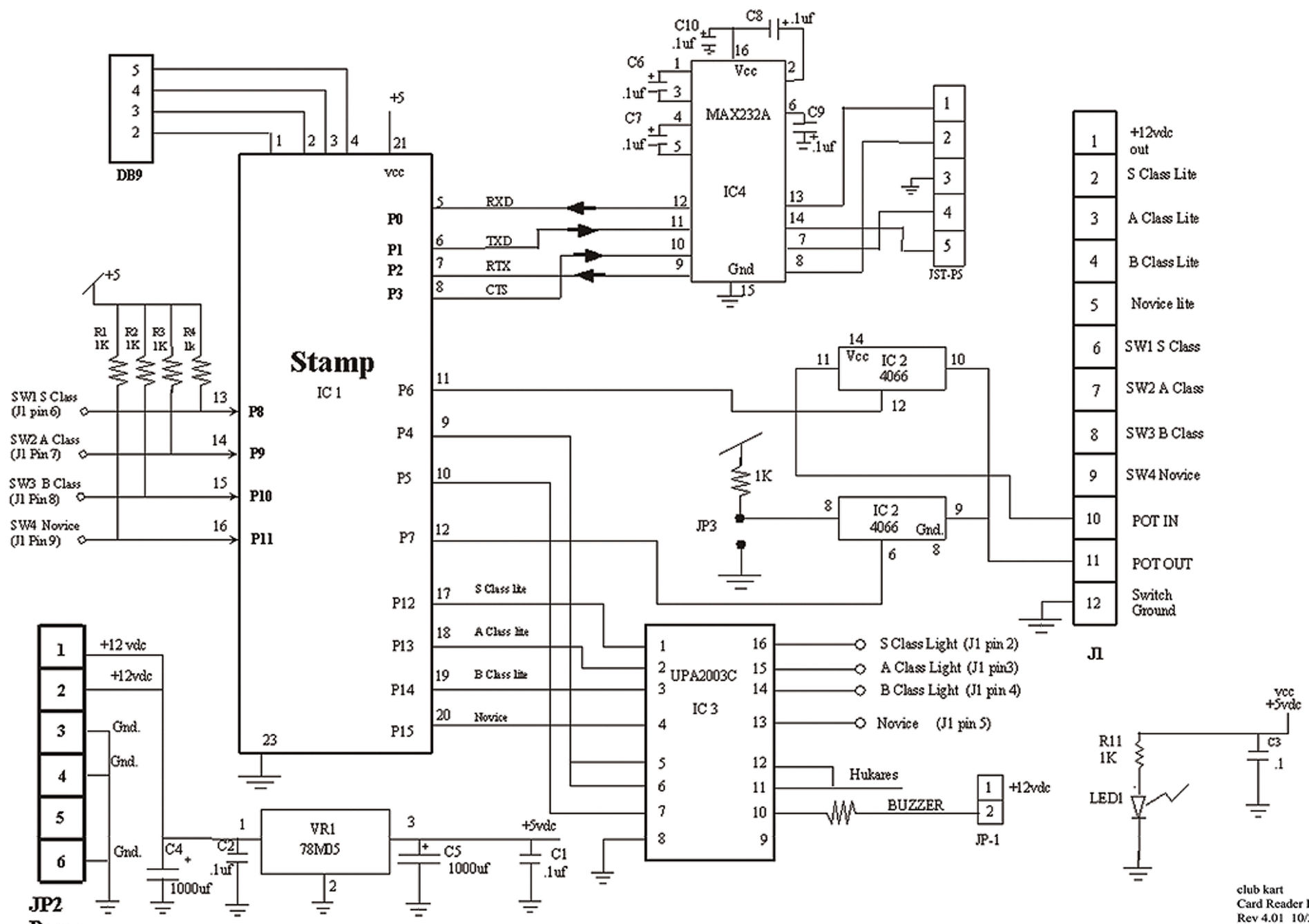



SEGA ENTERPRISES, INC. (USA)

45133 Industrial Drive
Fremont, CA 94538
(650) 632-7580 phone
(650) 632-7594 fax